

Features

- Multifunctional K-Band Testsystem
- CW VCO Transmitter 23...25GHz, 20dBm
- Received Signal Frequency Measurement
- Received Signal Power Meter
- Active Doppler Target Simulator
- Auxiliary IF Power Meter
- Standalone Operation or Hosted Operation
- USB and Serial Interface to Hostcomputer
- Extremely Compact and Rugged Construction

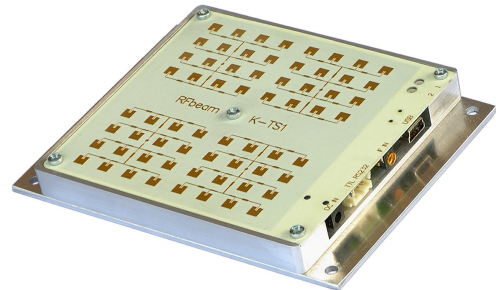

Applications

- Radarmodule Testsystems
- Production Final Inspection
- System Tuning and Adjustment
- Automatic Microwave Test Equipment

Description

K-TS1 is a fully integrated radarmodule test-system for K-band transmitters, receivers and transceivers. It consists of a digitally controlled synthesizer and transmitter, a selective receiver with power indicator and a synthetic doppler target simulator.

Its extremely compact construction makes it an ideal component for production and quality control systems. The "all-in-one" approach of K-TS1 simplifies geometrical adjustment of the

unit under test because it has to be targeted only once for all tests.

K-TS1 may be connected to a simple terminal software as well as to a high sophisticated measurement and analysis software.

Streaming or singleshot operation modes provide high flexibility.

With only a few keystrokes, you get high performance measurement results.

Functional Overview

Antenna and Connector Arrangement

Target Rx Antenna	Transmitter Antenna	LED 1	Operational Indicators
		LED 2	
		USB	Host Software (Terminal, LabVIEW etc)
Target Tx Antenna	Receiver Antenna	TTL I/O	Digital I/O Port
		RF In	RF power measurement for evaluating UUT system sensitivity
		DC In	Power supply 15 ... 24V

Fig. 1: Antenna and Connector Arrangement

K-TS1 Subsystems

The K-TS1 testsystem consists of 3 RF subsystems and 2 infrastructure subsystems:

- 1 **Target Simulator:** This subsystem simulates a moving object generating a stereo doppler signal. It receives the 24GHz carrier signal of a K-band doppler module and sends back a signal corresponding to an approaching target with a programmable frequency of -9999Hz to 9999Hz, where the sign simulates the direction of the target.
- 2 **Measuring System:** This subsystem may be used for measuring RF characteristics of K-band receivers, transmitters and transceivers. It sends a programmable, highly stable carrier frequency from 23...25GHz to a 4x4 path array antenna. At the same time, the RF generator is used as LO for the receiver. The receiver part allows measuring incoming RF power at a separate patch antenna. It also delivers signals for a high precision frequency determination of the incoming RF signal.
- 3 **AUX RF Power Meter:** This subsystems measures the input power arriving at an RF connector. It may be used e.g. for measuring the system sensitivity of external receivers, antenna test stands etc.
- 4 **Microcontroller System:** This subsystem controls all RF systems and builds the interface to hostsystems. It may be configured to operate K-TS1 as standalone system as well as under full host control. The TTL I/O is used to communicate with external hardware. The USB host interface assures a universal communication either with terminal emulation program or with high sophisticated, automated test stands.
- 5 **Power Supply:** K-TS1 may be operated from simple 15V..24VDC adaptors.

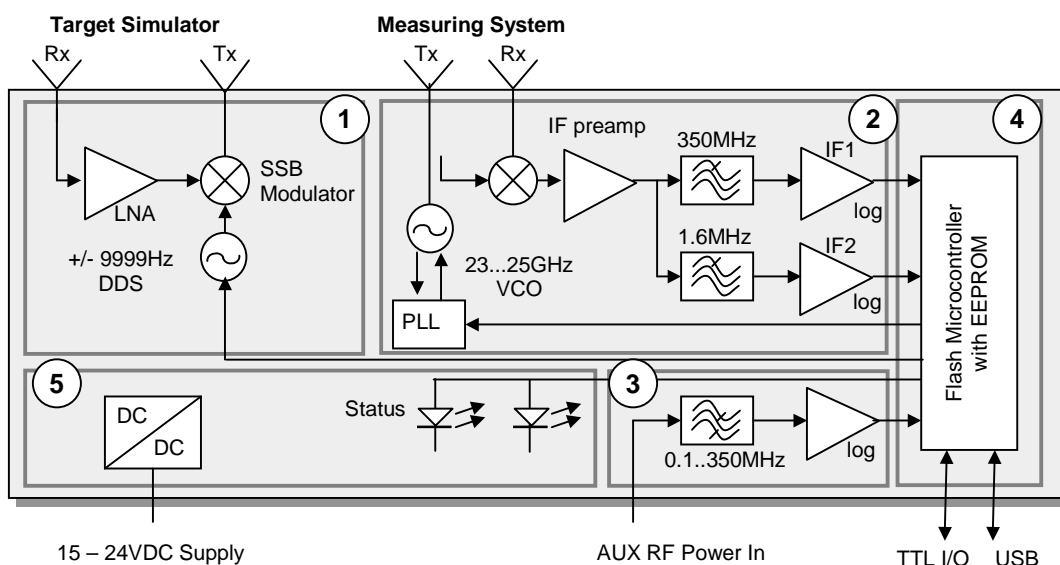

Fig. 2: Block Diagram

Characteristics

Parameter	Conditions / Notes	Symbol	Min	Typ	Max	Unit
Operating conditions						
Supply voltage		V_{cc}	15	24	26	V
Supply current	Transmitter active	I_{cc}		100		mA
Operating temperature		T_{op}	0		+60	°C
Storage temperature		T_{st}	-20		+80	°C
Transmitter						
Transmitter frequency	digitally adjustable	f_{TX}	23.000		25.000	GHz
Frequency step width		f_{step}		1		MHz/stp
Output power	EIRP	P_{TX}	+13	+17	+20	dBm
Frequency drift vs temperature	0°C .. +60°C	$f_{TXDrift}$			+/- 25	kHz/°C
Maximum frequency error	0°C .. +60°C	$f_{TXError}$		+/- 1.2		MHz
Phase Noise	@ 100kHz offset	$P_{TxNoise}$		-95		dBc/Hz
Spurious	@ 62.5kHz offset	P_{spur1}			-25	dBc
Out of Band Spurious	$f < 23.000\text{GHz}$ or $f > 25.000\text{GHz}$	P_{spur2}			-20	dBm
Receiver						
Frequency range		f_{RX}	23.000		25.000	GHz
IF1 bandwidth	Band is centered around TX frequency	BW_{IF1}		$f_{TX} \pm 350$		MHz
IF2 bandwidth	Band is centered around TX frequency	BW_{IF2}		$f_{TX} \pm 1.6$		MHz
Noisefloor IF1	full bandwidth	$P_{noiseIF1}$		-68		dBm
Noisefloor IF2	full bandwidth	$P_{noiseIF2}$		-89		dBm
RX power indicator range IF1	Power seen from RX-Antenna	P_{IF1}	-65.0		-10.0	dBm
RX power indicator range IF2	Power seen from RX-Antenna	P_{IF2}	-86.0		-10.0	dBm
RX power detector resolution	IF1 / IF2	R_{PRx}		0.1		dB
RX power accuracy	IF1 / IF2	$P_{RXError}$			+/- 3	dB
RX frequency detector resolution		R_{fRX}		1		MHz
Frequency measurement error		$f_{RXError}$			+/- 1	MHz
RX frequency detector sensitivity	power range for reliable acquisition	P_{fRX}	-50.0		-10.0	dBm
Doppler Target						
Frequency range	Transmit frequency of UUT	f_{TG}	23.500		24.500	GHz
Doppler frequency range	Software Adjustable	$f_{Doppler}$	1		9999	Hz
Aequivalent reflectivity	approximative indication Serial# < 1108xxxx Serial# >= 1108xxxx	RCS RCS		10 200		mm ² cm ²
AUX Power Input						
AUX bandwidth	-3dB Points	BW_{AUX}	0.1		350	MHz
Noisefloor AUX	full bandwidth	$P_{noiseAUX}$		-75.0		dBm
AUX power indicator range		P_{AUX}	-72.0		+15.0	dBm
AUX power detector resolution		R_{PAUX}		0.1		dB
AUX power accuracy		$P_{AUXError}$			+/- 3	dB
AUX input impedance		R_{in}		50		Ohm
Host Interface						
USB	Virtual COM Port 38.4kB, 8N1, no handsh.	PC Driver	www.ftdichip.com/Drivers/VCP.htm			
TTL I/O Connector	Input TTL (internal pull up = 47k)	V_{low}	0	0.4	0.6	V
	Output TTL @ -10mA	V_{high}	4.5		5	V

Antenna Diagrams

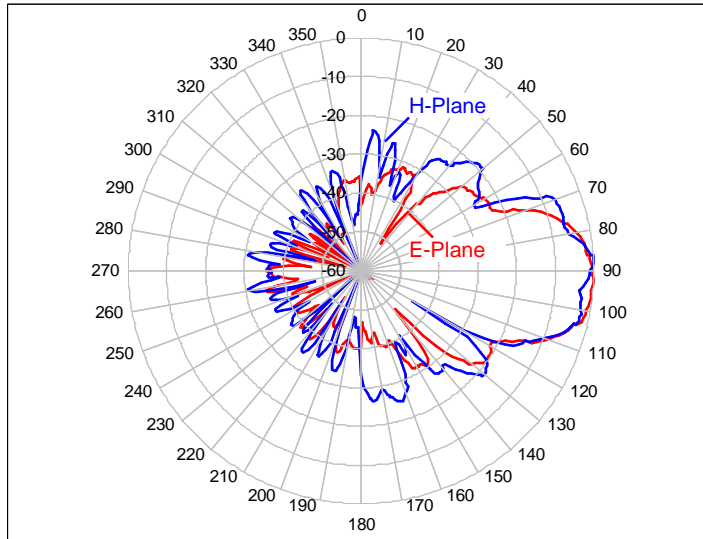

Fig. 3: Field Pattern of Tx Antenna

Host Interface

The K-TS1 is equipped with a USB interface FT232R from [FTDI Chip](http://www.ftdichip.com). To operate the USB interface, you need a so called "Virtual Com Port" or VCP driver. This driver emulates a serial interface so that the USB device appears to the PC as an additional COM port.

VCP Drivers are available for all major operating systems at: <http://www.ftdichip.com/Drivers/VCP.htm>.

Communication Settings

The USB VCP (Virtual Com Port) Interface works with the following setting:

Baudrate:	38'400 baud
Databits:	8
Parity:	none
Handshake:	none

Communication Protocol

Communication protocol is ASCII character based, so that a simple terminal software is sufficient to operate the K-TS1 system.

The K-TS1 device always acts as server / producer. So K-TS1 is always under control of the client system. The client may be a terminal or a host software like LabVIEW or a software located in the UUT itself. The protocol is shown here by means of a standard ANSI terminal software such as Windows "Hyperterminal". Acquisition software should simply bypass the help texts and escape sequences and works with the same commands as shown here.

Startup Message and Sections

K-TS1 sends the following screen after receiving an [Enter] key from the terminal program:

```

RFbeam K-TS1 24GHz Test System #09160219
=====
key      vers  description  27  actual values
-----
[c] CW Carrier on/off      : 0      [0=off, 1=on]
[t] Target on/off         : 0      [0=off, 1=on]
[f] TX-frequency          : 24.125 [23.000 .. 25.000GHz]
[q,w,e] Frequency ++
[i,o,p] Frequency -
[g] Target Frequency      : 200    [-9999 .. 9999Hz]
[s] Setup
[r] Store to EEPROM
[b] Jump in Bootloader
-----
[m] Measure f/P once
[l] Measure f/P in loop
[a] Cyclic table update   : 0      [0=off, 1=on]
[-] Transmitter EIRP     :        [dBm]
[-] IF1 power             :        [dBm]
[-] IF2 power             :        [dBm]
[-] AUX power             :        [dBm]
[-] Target EIRP          :        [dBm]
=====
==>

```

System commands

Setup commands

Display commands

K-TS1 measuring results displayed at command "a1"

K-TS1 command and result line

Fig. 4: K-TS1 output structure at a standard terminal program

K-TS1 Command Set

Overview

All commands must be followed by an [Enter] key (ASCII 0x0d). Exception: Fast up ([q], [w], [e]) and down ([i], [o], [p]) adjustment keys. Cyclic operations can be cancelled by [Enter] or [Esc] keys.

Key	Param.	System Reaction
c	0 1	K-TS1 transmits a CW carrier at a frequency set by [f].
t	0 1	Turns on the Doppler target simulator. The signal received at "target Rx antenna" will be amplified, SSB modulated by the programmable target frequency and sent back via the "target Tx antenna". Tip: do not use cyclic inline display [l] when using this function. Otherwise there will possibly be distortions in the doppler signal.
f	23.000 ... 25.000	Carrier frequency is set to f with a resolution of 1 MHz. Please note, that all digits including the decimal point must be entered.
q,w,e	--	Fast frequency increase by 1MHz, 10MHz, 100MHz. This is very handy for frequency sweep by a host computer.
i, o, p	--	Fast frequency decrease by 1MHz, 10MHz, 100MHz
g	-9999 ... 9999	Target simulator frequency may be set with a resolution of 1Hz. The sign sets the simulated direction of the target. A positive value will simulate a forward moving target and a negative value a backward moving target. Please note, that all digits including leading zeroes must be entered. Range for K-TS1 with Firmware smaller then V3.01 = 0 .. 4000Hz Range for K-TS1 with Firmware equal or higher then V3.01 = -9999 .. 9999Hz
s	--	Calibration and special mode settings values for the K-TS1 system. See Special I/O Settings
r	--	Nonvolatile storage of the actual settings. Use this functions for standalone operation of K-TS1
b	--	This command is used for updating K-TS1 firmware. Refer to the release notes on http://www.rfbeam.ch/
m	--	Performs a "oneshot" measurement of Rx frequency, Rx power and Power at the "Aux" connector
l	--	Performs a "cyclic" measurement of Rx frequency, Rx power and Power at the "Aux" connector. Stop cyclic display by [Esc]. Tip: Switch doppler target off when using this function.
a	0 1	Performs a "cyclic" measurement of internal values (refer to Fig. 4). Turn CW carrier on to get values.
Enter		Enters commands and refreshes the screen
Esc		Escapes/stops running command [l] and refreshes the screen

Modes and Indicators

Two LEDs named LED1 (green) and LED2 (red) visualize the actual operating mode of the system. Green LED signals "K-TS1 under power" or flashes, if continuous measurements are performing. Red LED is ON or flashing, if K-TS1 is transmitting a carrier.

Mode	Parameters		LED Indications	
	c	t	LED1	LED2
Module ON, no operation	0	0	LED1:	LED2:
CW Carrier ON, Target OFF	1	0	LED1:	LED2:
CW Carrier ON, Target ON	1	1	LED1:	LED2:
CW Carrier OFF Target ON	0	1	LED1:	LED2:
Loop Mode [l], no signal at Rx	0	0	LED1:	LED2:
Loop Mode [l], receiving signal at Rx	0	0	LED1:	LED2:

Fig. 5: Indicator patterns

Table mode (a=1) does not influence the LED patterns. With a=1, patterns only depend on the state of 't' and 'c'.
 With 'm' (oneshot), green LED is interrupting for 200ms. This may also be interpreted as indication of host communication via USB or terminal

Command Examples

Cyclic inline display (Loop Mode)

This is the most common command which displays frequency and power of a UUT. At the command line, you enter the following keys. A key is marked in [brackets].

Step 1:	[l] [Enter]	This turns on cyclic display at the command line
Step 2:	[Esc]	Stop cyclic display

```

RFbeam K-TS1 24GHZ Test System #09160219
=====
Program Version v3.01 Jan 27 2011

[c] CW Carrier on/off      : 1      [0=off, 1=on]
[t] Target on/off         : 0      [0=off, 1=on]
[f] TX-Frequency          : ---- [23.000 .. 25.000GHz]
[q,w,e] Frequency ++
[i,o,p] Frequency -
[g] Target Frequency      : 200    [-9999 .. 9999Hz]
[s] Setup
[r] Store to EEPROM
[b] Jump in Bootloader
-----
[m] Measure f/P once
[1] Measure f/P in loop
[a] Cyclic table update   : 0      [0=off, 1=on]
[-] Transmitter EIRP     :      [dBm]
[-] IF1 power             :      [dBm]
[-] IF2 power             :      [dBm]
[-] AUX power             :      [dBm]
[-] Target EIRP          :      [dBm]

f (Rx)   P (Rx)   P (AUX)
24.203GHz -35.3dBm -70.9dBm
    
```

controlling carrier (local oscillator) happens automatically in [l] and [m] modes.

Choosing [l] key turns on cyclic results display

Values are displayed and updated at a rate of 1Hz approx. Power indications are fully corrected values arriving at the antenna or connector

Fig. 6: Loop mode: Cyclic measurement of arriving power and frequency

Doppler Target

This is an example of a test stand operation for Doppler radar transceivers. First, you had measured transmitter characteristics as in the example before. Now you like to know an approximative receiver sensitivity. K-TS1 acts as "moving target" and you measure the level of the Doppler signal at the UUT with an oscilloscope or with the software of the UUT itselfs.

(Step 1):	[Enter]		<i>If necessary, terminate a previous cyclic display</i>	
(Step 2):	[c]	[0]	[Enter]	<i>switch off the CW carrier, it may interfere with the UUT carrier</i>
Step 3:	[t]	[1]	[Enter]	<i>This turns on the Doppler target simulator (and causes a doppler signal at the UUT)</i>
Step 4:	[g]	nnnn	[Enter]	<i>Set target frequency by entering 4 digits including leading zeroes. With Software >=V3.01 you can control the simulated direction with the sign of the frequency.</i>

```
RFbeam K-TS1 24GHz Test System #09160219
=====
Program Version V3.01 Jan 27 2011

[c] CW Carrier on/off      : 0      [0=off, 1=on]
[t] Target on/off         : 1      [0=off, 1=on]
[f] TX-frequency         : 24.125 [23.000 .. 25.000GHz]
[g,w,e] Frequency ++
[i,o,p] Frequency -
[g] Target Frequency     : 200    [-9999 .. 9999Hz]
[s] Setup
[r] Store to EEPROM
[b] Jump in Bootloader
[m] Measure f/P once
[l] Measure f/P in loop
[a] cyclic table update   : 0      [0=off, 1=on]
[-] Transmitter EIRP     :         [dBm]
[-] IF1 power            :         [dBm]
[-] IF2 power            :         [dBm]
[-] AUX power            :         [dBm]
[-] Target EIRP          :         [dBm]

==>
```

*This command activates the doppler target. It receives the carrier of the UUT, modulates it with an adjustable frequency and sends it back to the UUT.
Frequency to speed relation is 44Hz / km/h*

No cyclic inline display should be activated!

Fig. 7: K-TS1 Operating as Synthetic Doppler target.

Cyclic Table Display

This is an example of an in-depth analysis of Doppler radar transceivers and antenna characteristics. AUX power may be used for any power measurements of signals from -72dBm to +15dBm in a frequency range from 100kHz and 350MHz. A typical application is a readout of a high bandwidth mixer output of a radar receiver exposed to the CW carrier of the TS-1 module.

Using IF1 and IF2 readouts are intended mainly for highly dynamic power measurements by ramping the CW carrier frequency and processing the value of the narrow band IF2 filter.

(Step 1):	[Enter]		<i>If necessary, terminate a previous cyclic display</i>	
Step 2:	[c]	[1]	[Enter]	<i>This turns on the K-TS1 local oscillator and transmitter</i>
Step 3:	[a]	[1]	[Enter]	<i>Turn on the table display mode</i>
(Step 4):	[t]	[1]	[Enter]	<i>This turns on the Doppler target simulator (and causes a doppler signal at the UUT)</i>

```
RFbeam K-TS1 24GHz Test System #09160219
=====
Program Version V3.01 Jan 27 2011

[c] CW Carrier on/off      : 1      [0=off, 1=on]
[t] Target on/off         : 1      [0=off, 1=on]
[f] TX-frequency         : 24.125 [23.000 .. 25.000GHz]
[g,w,e] Frequency ++
[i,o,p] Frequency -
[g] Target Frequency     : 200    [-9999 .. 9999Hz]
[s] Setup
[r] Store to EEPROM
[b] Jump in Bootloader
[m] Measure f/P once
[l] Measure f/P in loop
[a] Cyclic table update   : 1      [0=off, 1=on]
[-] Transmitter EIRP     : 20.0  [dBm]
[-] IF1 power            : -33.6 [dBm]
[-] IF2 power            : -50.5 [dBm]
[-] AUX power            : -72.9 [dBm]
[-] Target EIRP          : -63.3 [dBm]

==>
```

*In [a] mode, turning on carrier oscillator is necessary to perform power measurements.
Setting of [t] is optional*

Choosing [l] key turns on cyclic results display

IF1 shows approximative Rx power got from the UUT

Target EIRP: power sent to the UUT (only if [t]=1)

No cyclic inline display should be activated!

Fig. 8: K-TS1 Table Display, while operating as target

Special I/O Settings



These settings are for experienced users only!

Special I/O available only in Software \geq V3.0 and Hardware Serial# > 0916xxxx

The special I/O appear at the TTL I/O Connection. The functionality depends on the mode of the K-TS1 system.

Normal Mode

This is the default mode, featuring all measuring functions.

Tuning Mode

Purpose:

Tuning mode can be used to adjust the carrier frequency of Radar transceivers during the production. In this mode, K-TS1 may be used as a standalone system and is typically built into a "Tuning Box". The "OK" frequency range can be set and stored in EEPROM by executing [b] and [m] commands. Frequency values may be displayed with an analogue current meter with a fixed scale controlled by a PWM value from the TTL I/O Connection.

Scaling:

PWM values are divided into 3 segments with different slopes. Only "High Limit" and "Low Limit" may be set according to Fig. 10. Rest of scaling is performed automatically.

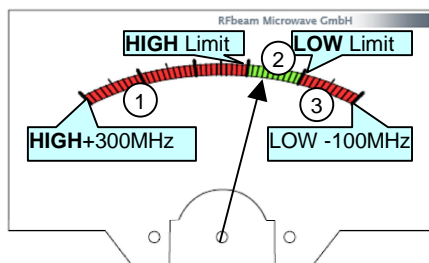

Scale segment	PWM ratio	Instrument display	OK LED Output
1 (High)	0 - 59%	0 - 59% of FS	Off
2 (Pass)	60% ... 80%	60% ... 80% of FS	ON
3 (Low)	81% ... 100%	81% ... 100%	Off

Important:

- Instrument = 0 highest frequency
- Green OK range is always at 60% ... 80% of full scale
- For setting the limits, see Fig. 10: Settings for "Tuning Mode"

Fig. 9: Instrument Scale

Instrument Output Electrical Characteristics:

Instrument ist driven via a series resistor by TTL I/O Connection, Pin 1(+) and Pin 3(-). The K-TS1 system outputs a PWM at 244Hz at a voltage level of 5V.

Recommended Instrument: 100uA FS, Ri=1k.

Recommended series resistor: 49kOhm.

Result (LED) Indicator Output:

An LED may be driven via a series resistor by TTL I/O Connection, Pin 2(+) and Pin 3(-).

This output is turned on as long as the measured frequency is in green range.

Result (USB) Output:

Serial USB interface may be used for debugging or automated control equipment. When K-TS1 operates in Tuning Mode, measuring results are shown in a similar format as in the Loop Mode (see Fig. 6).

24.203GHz -35.3dBm -70.9dBm <CR>

Select and Setting Tuning mode: (will become permanently stored in EEPROM)

Step 1:	[Enter]	If necessary, terminate a previous cyclic display
Step 2:	[s] [Enter]	Go to Setup Page
Step 3:	[m] [1] [Enter]	Select Tuning Mode
Step 4:	[b] nn.nnn [Enter]	Set lower limit of OK range
Step 5:	[n] nn.nnn [Enter]	Set higher limit of OK range
Step 6:	[x] [Enter]	SAVE SETTINGS and return to main page
Step 8:		Changes take place only after power on

```

RFbeam K-TS1 24GHz Test System #09160210
-----
[m] Operating Mode      : Tuning [0,1,2] (*)
[b] Tuning Frequency low : 24.100 [23.300-24.900GHz] (*)
[n] Tuning Frequency high : 24.150 [23.300-24.900GHz] (*)
-----
[a] Identification     : 09160210
[s] Oscillator Power   : 7.0 [dBm]
[d] Antenna Gain       : 12.0 [dBi]
[f] Antenna Center Frequency : 24.100 [GHz]
[g] Antenna Loss low   : 5.0 [dB]
[h] Antenna Loss high  : 10.0 [dB]
[j] IF1 Gain           : 0.2 [dB]
[k] IF2 Gain           : 1.0 [dB]
[l] AUX Loss           : 0.0 [dB]
[y] Target Conversion Loss : 1.5 [dB]
[-] Target Amplitude I : 48 [%]
[-] Target Amplitude Q : 42 [%]
[-] Target Offset I    : 210 [mV]
[-] Target Offset Q    : 188 [mV]
[-] Target Phase I/Q   : 108 [Deg]
-----
[x] Leave Setup and store User Parameters (*)
==>

```

Sub-Page 'Setup'

0 = Normal, 1 = Tuning, 2 = Testbench
 [b] used in Tuning Mode only: 80% PWM
 [n] J used in Tuning Mode only: 60% PWM
 FACTORY SETTINGS
 DO NOT ALTER!

Choosing x key turns to main page
 Changing become active after power on

Fig. 10: Settings for "Tuning Mode"

Test Bench Mode

A personalized Windows PC based Testbench Software may be purchased at www.rfbeam.ch. Get more informations at info@rfbeam.ch.

Purpose:

This mode corresponds fully to the Normal Mode, except the digital I/O capabilities. In this mode, K-TS1 can be used in an Automated Test Equipment (ATE) for testing Radar Transceivers. It features a digital input, represented as 'CTS' modem signal. It may be used for starting a test procedure e.g. A digital output represents an 'RTS' modem signal and may be used for driving a "pass" LED or similar.

Digital Input:

Digital Input is available at TTL I/O Connection, Pin 1(pulled up) and Pin 3(GND). You may directly connect a switch or an open collector driver to these pins. This input is represented by the 'CTS' modem signal at the USB serial connection.

Switch open: CTS active

Digital Output:

Digital Output is available at TTL I/O Connection, Pin 2(+) and Pin 3(GND).

An LED may be driven via a series resistor by TTL I/O Connection.

Selecting Testbench Mode: (will become permanently stored in EEPROM)

Step 1:	[Enter]	If necessary, terminate a previous cyclic display
Step 2:	[s] [Enter]	Go to Setup Page
Step 3:	[m] [2] [Enter]	Select Testbench Mode
Step 4:	[x] [Enter]	SAVE SETTINGS and return to main page
Step 5:		Changes take place only after power on

Application Notes

Typical Arrangement

The unit under test (UUT) is placed in front of the K-TS1 module with a distance of >30cm (in the farfield). For frequency measurements, it is not necessary to shield the whole arrangement. For power measurements, you should at least place a piece of K-band absorber on the groundplane (a wooden table is best). Most reliable results you get, if there is much free room around the setting, or you place the whole arrangement into a (wooden) chamber.

Pay attention to place the UUT in the correct polarization direction. Check this by rotating the UUT by 90° into the position, where K-TS1 shows maximum power.

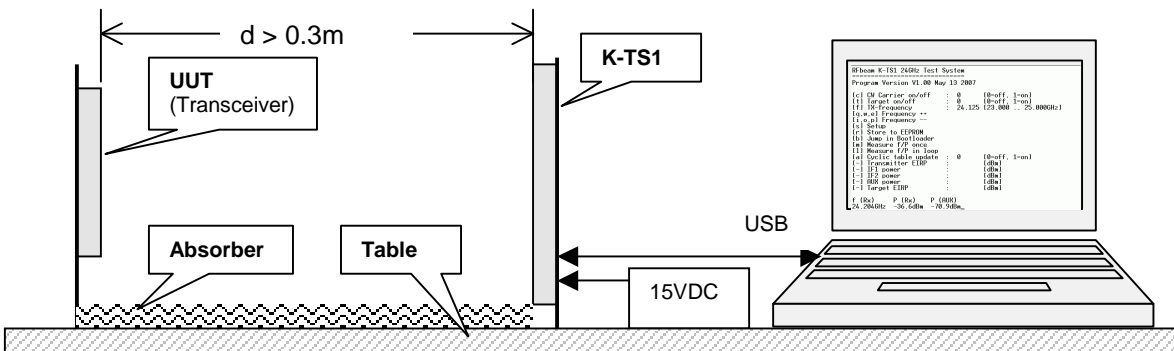

Fig. 11: Typical arrangement of a test-stand

Determinating UUT Tx Power (EIRP)

K-TS1 shows effective power arriving at its Rx antenna. To determine the effective radiated power by the UUT, we have to respect the attenuation of power over the distance *d* according to Fig. 12.

Example:

UUT distance *d* = 30cm. K-TS1 is set to display power in loop mode ('l=1').

Reading from K-TS1: -35.3dBm

Adding path loss from Fig. 12: + 50dB

 --> Radiated EIRP from UUT: + 14.7dBm (=30mW)

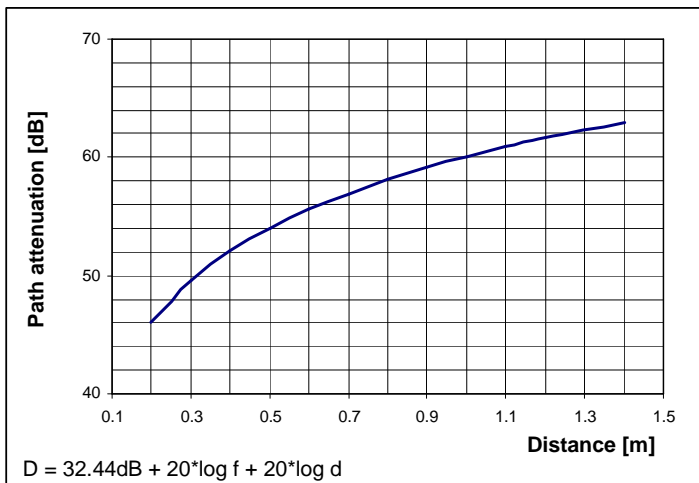

Fig. 12: Power attenuation over distance @24GHz

Using K-TS1 as Synthetic Target

For testing Doppler transceivers, you need normally a moving object, that reflects the transceiver's carrier and thus produces a Doppler signal in the transceiver.

The same test may be accomplished by using K-TS1 in a much more comfortable and reliable fashion as "synthetic target". This results in a programmable Doppler frequency at the target's IF output and a phase shift at I/Q outputs of $+90^\circ$ (corresponds to an approaching target). By operating the test-stand with a known target, you may calibrate your test-stand by using the IF output signal level of the UUT as a reference.

You get even more information on the behaviour of the UUT by using the K-TS1 "Table Display" mode (see Fig. 8). Based on the "Target EIRP" value, a calculation of UUT overall receiver sensitivity may be performed.

Using K-TS1 EEPROM Feature

K-TS1 as Standalone System

You may use K-TS1 without any host connection, if you have stored the desired operation mode in EEPROM.

This feature is useful in "Synthetic Target" mode (t=1). To enter this mode permanently, enter the following commands:

Step 1:	[Enter]			<i>If necessary, terminate a previous cyclic display</i>
Step 2:	[c]	[0]	[Enter]	<i>switch off the CW carrier, it may interfere with the UUT carrier</i>
Step 3:	[t]	[1]	[Enter]	<i>This turns on the Doppler target simulator (and causes a doppler signal at the UUT)</i>
Step 4:	[g]	nnnn	[Enter]	<i>Enter simulator frequency</i>
Step 5:	[r]		[Enter]	<i>K-TS1 answers with a short message</i>

From now, K-TS1 automatically works as synthetic target after each power on. You may alter this setting at any time and store a new configuration in EEPROM.

You may also use a standalone K-TS1 in "Tuning Mode". See chapter Tuning Mode.

Startup with Preset Parameters

Frequency and CW carrier state may be set to the desired values and stored to EEPROM by function [r]. From now, K-TS1 starts up with the new setting stored in EEPROM.

Connector and Pin Configuration

USB Connection

This cable is delivered together with K-TS1.

You may use a standard USB cable with USB type A and mini USB type B connectors.

Cable Side Type	Manufacturer Example	Distributor Example
Mini USB type B	USB A <--> Mini USB B cable 3m Lumberg 2480-03	Farnell #1308880

DC Power Supply Connection

This cable is delivered together with K-TS1.

Cable Side Type	Manufacturer Example	Distributor Example
0.7mm EIAJ DC connector	Lumberg 163 601	Farnell #1216982

TTL I/O Connection

This connection is activated in the modes "Tuning" and "Testbench" only.

See chapter Special I/O Settings.

Cable Side Type	Manufacturer Example	Distributor Example
Case JST PHR-3	JST	Farnell #3616198
Crimp contacts JST SPH-002T-P0.5S	JST	Farnell #3617210

Pin	Function in Tuning Mode	Function in Testbench Mode
1	PWM output for analog instrument	Input with 47k pull up. Routed to 'CTS' modem signal
2	'OK' output = high, if frequency in range	Output, routed from 'RTS' modem signal
3	GND	GND

Auxiliary RF Power Input

This connection is needed only, if you need to measure external RF power.

Cable Side Type	Manufacturer Example	Distributor Example
11 MCX-50-1-1/1110E for RG178 coax cable	Huber & Suhner	Farnell #4163436

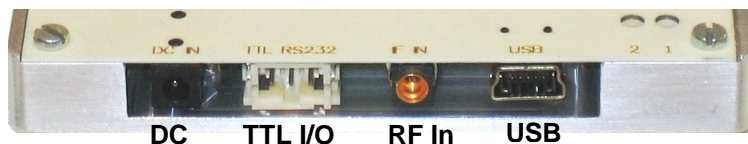

Outline Dimensions

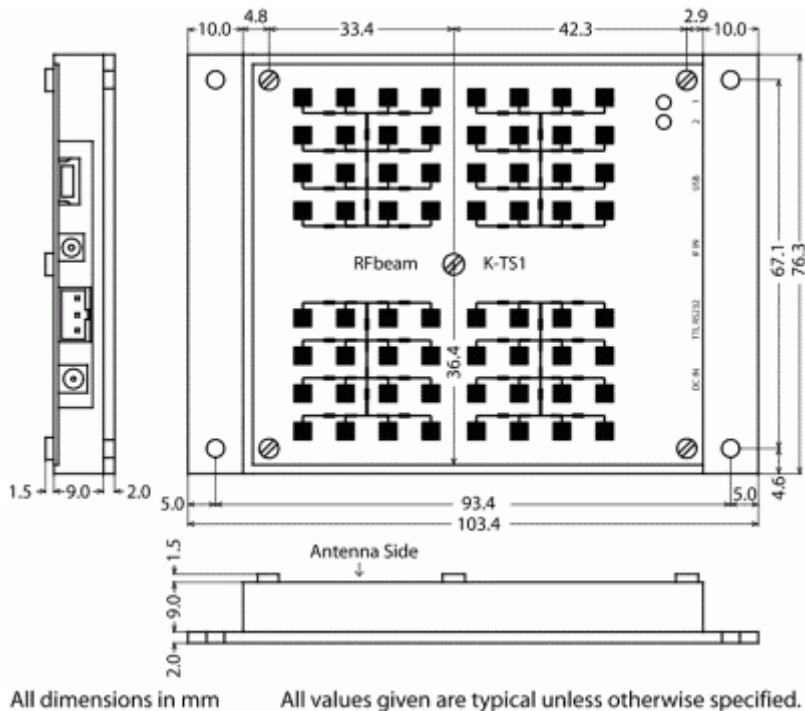

Fig. 13: Mechanical dimensions

Datasheet Revision History

Version	Date	Changes
1.0	07-June-2007	Initial release
2.0	02-Jan-2008	Target frequency adjustment added. K-TS1 software version V2.0 and later is required.
2.01	17-Jan-2008	Baudrate value on page 4: 38'400Baud
3	10-June-2009	Added new Modes "Tuning" and "Testbench" Changed TTL RS-232 connector to TTL I/O connector Special I/O available only in Software >= V3.0 and Hardware Serial# > 0916xxxx
3.1	11-March-2011	Added new direction simulator function in target mode

RFbeam does not assume any responsibility for use of any circuitry described, no circuit patent licenses are implied and RFbeam reserves the right at any time without notice to change said circuitry and specifications.